

Architectural
Woodwork Standards

CASEWORK

10

SECTION

SECTION 10

Casework

table of contents

INTRODUCTORY INFORMATION

| | |
|---|-----|
| Guide Specifications | 284 |
| Introduction | 285 |
| Casework Categories..... | 285 |
| Wood Casework | 285 |
| Decorative Laminate Casework | 285 |
| Solid Phenolic Casework..... | 285 |
| Contract Documents | 285 |
| Design Professional's Responsibility..... | 285 |
| Compliance to Seismic Requirements | 285 |
| Chemical and Stain Resistance | 285 |
| Abrasion Resistance | 285 |
| Unless Specified Otherwise | 285 |
| Corners..... | 285 |
| Finished Ends..... | 285 |
| Base/Toe | 285 |
| Storage, Janitor Closet and Utility Room Cabinets | 285 |
| Presentation Panels | 285 |
| Toe Base Height Variance | 285 |
| Surface Terminologies | 285 |
| Exposed Exterior Surfaces..... | 285 |
| Exposed Interior Surfaces | 286 |
| Semi-Exposed Surfaces..... | 286 |
| Concealed Surfaces | 286 |
| Surface Terminology by Illustration | 286 |
| Surface Finish Requirements..... | 287 |
| Exposed Exterior Surfaces..... | 287 |
| Exposed Interior Surfaces | 287 |
| Premium Grade | 287 |
| Semi-Exposed Surfaces..... | 287 |
| Concealed Surfaces | 287 |
| Construction Terminology | 288 |
| Frameless..... | 288 |
| Face Frame..... | 288 |
| Selection..... | 288 |

| | |
|---|-----|
| Cabinet and Door Interface Style Terminology | 288 |
| Flush Overlay | 288 |
| Overlay | 288 |
| Face Frame Construction..... | 288 |
| Flush Inset..... | 288 |
| Layout Requirements of Grained or Patterned Faces by Grade..... | 289 |
| Stile and Rail | 289 |
| Flush Panel | 289 |
| Economy Grade | 289 |
| Custom Grade..... | 289 |
| Premium Grade..... | 289 |
| Door and Applied Drawer Front Profiles | 289 |
| Edge Profiles | 289 |
| Retention Profiles..... | 289 |
| Cabinet Design Series..... | 290 |
| Casework Integrity..... | 290 |
| Cabinet Hardware | 290 |
| Drawer Slide Selection Guide | 290 |
| Degree of Extension | 290 |
| Static Load Capacity..... | 290 |
| Dynamic Load Capacity | 290 |
| Removal..... | 290 |
| Closing..... | 290 |
| Metal Sided Drawer Systems..... | 290 |
| Hinge Selection Guide | 291 |
| European style hinge..... | 291 |
| Wraparound hinge..... | 291 |
| Butt hinge | 291 |
| Adjustable Shelf Loading and Deflection | 291 |
| Construction Detail Nomenclature..... | 292 |
| Stub Tenon | 292 |
| Haunch Mortise and Tenon Joint..... | 292 |
| Conventional Mortise and Tenon Joint | 292 |
| Dowel Joint..... | 292 |
| French Dovetail Joint..... | 292 |
| Conventional Dovetail Joint..... | 292 |
| Drawer Lock Joint..... | 292 |
| Exposed End Details | 292 |

table of contents

INTRODUCTORY INFORMATION (continued)

| | |
|--|-----|
| Butt Joint | 292 |
| Shoulder Mitered Joint | 292 |
| Pocket Screw Joint | 292 |
| Through Dado | 293 |
| Blind Dado | 293 |
| Stop Dado | 293 |
| Dowel Joint | 293 |
| Dowel Screw Joint | 293 |
| Edgebanding | 293 |
| Miter/Miter Fold Joint | 293 |
| Spline Joint | 293 |
| Paneled Door Details | 293 |
| Specify Requirements For | 294 |
| Construction | 294 |
| Door and drawer front Interface | 294 |
| Door and drawer front edge profile | 294 |
| Toe base finish | 294 |
| Grain direction | 294 |
| Inside clearance | 294 |
| Seismic Fabrication and/or installation | 294 |
| Flame Spread | 294 |
| Moisture resistance | 294 |
| Insulation from adjacent heating cooling sources | 294 |
| Hardware | 294 |
| Laboratory features | 294 |
| Recommendations | 294 |
| If Field Finished | 294 |
| Before Finishing | 294 |
| Concealed Surfaces | 294 |
| Review | 294 |
| Structural Members | 294 |

COMPLIANCE REQUIREMENTS

GENERAL

| | |
|---|-----|
| Basic Considerations | 295 |
| Grades | 295 |
| Economy | 295 |
| Custom | 295 |
| Premium | 295 |
| Grade Limitations | 295 |
| Contract Documents | 295 |
| Acceptable Requirements | 295 |
| Aesthetic Requirements | 295 |
| Surface Categories | 295 |
| Cabinet Surface Terminology Illustrations | 295 |
| Exposed Exterior | 296 |
| Exposed Interior | 296 |
| Semi-exposed | 296 |
| Concealed | 296 |
| Solid Phenolic | 296 |
| Cabinet Construction | 296 |
| Frameless | 296 |
| Face Frame | 297 |
| Cabinet and Door Interface | 297 |
| Overlay | 297 |
| Flush Inset | 297 |
| Flush Overlay | 297 |
| Casework Integrity | 297 |
| Hardware | 297 |
| Cabinet Design Series | 297 |
| Casework Concept Drawings | 297 |
| To Prevent Telegraphing | 297 |
| Industry Practices | 298 |
| Structural Members | 298 |
| Wall Ceiling and Floor | 298 |
| Priming | 298 |
| Surfacing | 298 |

COMPLIANCE REQUIREMENTS (continued)

GENERAL (continued)

Basic Considerations (continued)

| | |
|--|-----|
| Industry Practices | 298 |
| Casework Dimension Ranges | 298 |
| Base..... | 298 |
| Wall Hung | 298 |
| Tall Storage..... | 298 |
| Reception..... | 298 |
| Tellers Counter..... | 298 |
| Base Cabinet, Stretcher, Layout and Construction | 299 |
| Corners..... | 299 |
| Finish Ends..... | 299 |
| Base/Toe | 299 |
| Storage, Janitors Closet and Utility Room Cabinets | 299 |
| Presentation Panels | 299 |
| Toe Base Height Variances | 299 |
| Layout..... | 300 |
| Stile and Rail..... | 300 |
| Flush Panel..... | 300 |

PRODUCT

| | |
|------------------------------|-----|
| Scope | 301 |
| Typical Inclusions..... | 301 |
| Typical Exclusions..... | 301 |
| Default Stipulation | 302 |
| Exposed Knuckle Hinges | 302 |
| Reveal Overlay | 302 |
| Rules | 302 |
| Errata | 302 |
| Basic Rules..... | 302 |
| Aesthetic..... | 302 |
| Woodwork..... | 302 |
| Lumber | 302 |
| Sheet Products..... | 302 |
| Backing Sheet | 302 |
| All Materials..... | 302 |
| Surface Categories | 302 |
| Exposed Exterior | 302 |

| | |
|--------------------------------------|-----|
| Exposed Interior | 302 |
| Semi-Exposed | 302 |
| Concealed..... | 303 |
| Hardware | 303 |
| Conform To..... | 303 |
| Furnished and Installed..... | 303 |
| Uniform Plated / Power Coated..... | 303 |
| Manufacturer's Name..... | 303 |
| First Class Workmanship | 303 |
| Locks..... | 303 |
| Drawer Slides..... | 303 |
| Shelf Rests..... | 303 |
| Pocket Door Hardware..... | 303 |
| Base Adjusters | 304 |
| Multiple Hardware Options..... | 304 |
| Casework | 304 |
| Panel Components | 304 |
| Frameless Construction | 304 |
| Separately Applied Countertops | 304 |
| Storage | 304 |
| Cabinets over 72"..... | 304 |
| Sliding Presentation Boards..... | 304 |
| Hot Melt Applied..... | 304 |
| Prefinishing | 304 |
| Cut Outs..... | 304 |
| Cathedral | 304 |
| Cabinet Doors with Glass Lights..... | 304 |
| First Class Workmanship | 304 |
| Material Rules | 305 |
| Grain or Directional Patterned | 305 |
| Light Valance | 305 |
| Vinyl | 305 |
| Glass Shelves | 305 |
| Opaque Finish..... | 305 |
| Transparent Finish, Veneer..... | 305 |
| Semi-Exposed..... | 305 |
| Concealed..... | 305 |

table of contents

COMPLIANCE REQUIREMENTS (continued)

PRODUCT (continued)

Material Rules (continued)

| | |
|-----------------------------------|-----|
| Wood Casework..... | 306 |
| Exposed Exterior..... | 306 |
| Transparent Finish..... | 306 |
| Opaque Finish..... | 306 |
| Exposed Interior..... | 306 |
| Transparent Finish..... | 306 |
| Opaque Finish..... | 306 |
| Semi-Exposed..... | 306 |
| Drawer Box..... | 306 |
| Surfaces..... | 306 |
| Dividers..... | 306 |
| Sides, Backs and Subfront..... | 307 |
| Cores..... | 307 |
| Minimum Thickness..... | 307 |
| Bottoms..... | 307 |
| Cores..... | 307 |
| Minimum Thickness..... | 307 |
| Decorative Laminate Casework..... | 307 |
| Exposed Exterior..... | 307 |
| Exposed Interior..... | 307 |
| Semi-Exposed..... | 307 |
| Drawer Box..... | 307 |
| Surfaces..... | 307 |
| Dividers..... | 308 |
| Sides, Backs and Subfront..... | 308 |
| Cores..... | 308 |
| Minimum Thickness..... | 308 |
| Bottoms..... | 308 |
| Cores..... | 308 |
| Minimum Thickness..... | 308 |
| Solid Phenolic Casework..... | 308 |
| Exposed Exterior..... | 308 |
| Exposed Interior..... | 308 |
| Semi-Exposed..... | 308 |

| | |
|--|-----|
| Machining Rules..... | 309 |
| Exposed Surfaces and Semi-exposed..... | 309 |
| Smoothness..... | 309 |
| Sharp Edges..... | 309 |
| Top Flat..... | 309 |
| Profiled..... | 309 |
| Turned..... | 309 |
| Cross Sanding..... | 309 |
| Tear Outs, Knife Nicks..... | 309 |
| Knife Marks..... | 309 |
| Glue or Filler..... | 309 |
| HPDL, PVC, and Prefinished Wood..... | 309 |
| Overlap..... | 309 |
| Chip Out..... | 309 |
| Over Machined..... | 309 |
| Assembly Rules..... | 310 |
| These Standards..... | 310 |
| Joints at Assembled Woodwork..... | 310 |
| Flushness Horizontal..... | 310 |
| Fixed Horizontal..... | 310 |
| Gap Test A..... | 310 |
| Gap Test B..... | 311 |
| Gap Test C..... | 311 |
| Joinery..... | 311 |
| Bottom Edges..... | 311 |
| Visible Edges..... | 311 |
| Adjustable Shelves..... | 311 |
| Bottom Edge..... | 311 |
| Top Edge..... | 311 |
| Edgebanding..... | 311 |
| Dadoes or Lock Joints..... | 311 |
| Tee Banding..... | 311 |
| Drawers..... | 312 |
| Sides..... | 312 |
| Flush Overlay..... | 312 |

SECTION 10

Casework

table of contents

COMPLIANCE REQUIREMENTS (continued)

PRODUCT (continued)

Assembly Rules (continued)

Drawers (continued)

| | |
|------------------------------|-----|
| Joints..... | 312 |
| Slides..... | 312 |
| File Drawers..... | 312 |
| Locks..... | 312 |
| Trays, Bins..... | 312 |
| Fronts and False Fronts..... | 312 |
| Bottoms..... | 313 |

Doors.....

| | |
|------------------------|-----|
| Flush Overlay..... | 313 |
| Back Beveled..... | 313 |
| Core Thickness..... | 313 |
| Maximum door size..... | 313 |
| Door Thickness..... | 313 |
| Stop Silencers..... | 313 |
| Core..... | 313 |
| Locks..... | 313 |
| Glass..... | 313 |
| Hinged..... | 313 |
| Stile and Rail..... | 315 |
| Panel..... | 315 |
| Sliding..... | 315 |
| Frameless Glass..... | 316 |

Aprons.....

Ends and Divisions.....

Tops and Bottoms.....

Security and Dust Panels.....

Stretchers.....

Backs.....

Toe Bases, Kicks, and Sleepers.....

Levelers.....

Moveable Toes.....

| | |
|--|-----|
| Shelves..... | 318 |
| Thickness..... | 318 |
| Grain and Directional Pattern..... | 318 |
| Dividers..... | 318 |
| Uniform Thickness..... | 318 |
| Hardboard Cabinets over 72"..... | 318 |
| Glass..... | 318 |
| Fixed Shelves..... | 318 |
| Adjustable Shelves..... | 318 |
| Conformance in Thickness..... | 318 |
| Length..... | 321 |
| Depth..... | 321 |
| Supported..... | 321 |
| Metal Shelf Standards..... | 321 |
| Bored Hole Shelf Rest System..... | 321 |
| Pullout Shelves..... | 321 |
| Bread/Cutting Boards..... | 321 |
| Writing and Utility Shelves..... | 321 |
| Clothes Poles or Rods..... | 321 |
| Wardrobes..... | 321 |
| Anchor Strips..... | 321 |
| Moveable Cabinets..... | 322 |
| Glides..... | 322 |
| Casters..... | 322 |
| Metal Frame or Diagram Type Double Bottom..... | 322 |
| Lock Joint Corners..... | 322 |
| Joinery..... | 322 |
| Securely Fastened..... | 322 |
| Assembled Square and True..... | 322 |
| Securely Glued..... | 322 |
| Scribing..... | 323 |
| None..... | 323 |
| Furnished..... | 323 |
| Fillers and Molds..... | 323 |
| Trim Members..... | 323 |
| Soffit and Facia Panels..... | 323 |
| Options..... | 323 |
| Closure..... | 323 |

table of contents

COMPLIANCE REQUIREMENTS (continued)

PRODUCT (continued)

Assembly Rules (continued)

| | |
|--|-----|
| Clearance and Tolerances | 323 |
| Edge Alignment and Flushness..... | 323 |
| Maximum Uniform Gap | 324 |
| Reveal Overlay Frameless | 324 |
| Flush Overlay Frameless..... | 324 |
| Reveal Overlay Face Frame..... | 324 |
| Warp and Twist | 325 |
| Wood Casework | 325 |
| Visible Edges..... | 325 |
| Drawers..... | 325 |
| Doors..... | 325 |
| Face Frames | 326 |
| Tops and Bottoms | 326 |
| Flush Inset Doors | 326 |
| For Decorative Laminate Casework | 326 |
| Exposed Edges | 326 |
| Drawers..... | 326 |
| Doors..... | 326 |
| Solid Phenolic Casework..... | 326 |
| Edgebanding..... | 326 |
| Drawer..... | 326 |
| Door | 326 |
| Aprons..... | 326 |
| Shelves | 326 |
| Tops and Fixed Bottoms..... | 326 |
| Ends and Divisions..... | 326 |
| Security and Dust Panels..... | 326 |
| Stretchers..... | 326 |
| Bread/Cutting Boards..... | 326 |
| Joinery..... | 326 |

INSTALLATION

| | |
|---|-----|
| Care, Storage and Building Conditions | 327 |
| Contractor is Responsible For..... | 327 |
| Installer is Responsible For | 327 |
| Rules | 328 |
| Errata | 328 |
| Basic Rules | 328 |
| Aesthetic..... | 328 |
| Transparent Finished..... | 328 |
| Repairs | 328 |
| Installer Modifications..... | 328 |
| Casework | 328 |
| These Standards | 328 |
| Gaps Test I | 328 |
| Flushness Test J..... | 329 |
| Gaps, Edge Alignment and Flushness | 329 |
| Scribing | 329 |
| Closure..... | 330 |
| Exposed Fasteners | 330 |
| Casework Wall Anchorage | 330 |
| Nail Holes | 331 |
| Glue..... | 331 |
| Caulking | 332 |
| Require allowable fastener holes | 332 |
| Equipment Cutouts..... | 332 |
| Hardware..... | 332 |
| Areas of Installation..... | 332 |

TESTS

| | |
|---|-----|
| Basic Considerations | 333 |
| Fabricated and Installed..... | 333 |
| Smoothness | 333 |
| KCPI..... | 333 |
| Sanding..... | 333 |
| Gaps, Flushness, Flatness and Alignment | 333 |
| Illustrations..... | 334 |

Guide Specifications

Are available through the Sponsor Associations in interactive digital format including unique and individual quality control options.

The Guide Specifications are located at:

Architectural Woodwork Institute (AWI)

www.awinet.org

Architectural Woodwork Manufacturers Association of Canada (AWMAC)

<http://awmac.com/aws-guide-specifications>

10

Woodwork Institute (WI)

www.woodworkinstitute.com/publications/aws_guide_specs.asp

introductory information

INTRODUCTION

Section 10 includes information on Wood, Decorative Laminate, and Solid Phenolic Faced Casework and their related parts.

Quality assurance can be achieved by adherence to the AWS and will provide the owner a quality product at competitive pricing. Use of a qualified Sponsor Member firm to provide your woodwork will help ensure the manufacturer's understanding of the quality level required. Illustrations in this Section are not intended to be all inclusive. Other engineered solutions are acceptable. In the absence of specifications; methods of fabrication shall be manufacturer's choice. The design professional, by specifying compliance to the AWS increases the probability of receiving the product quality expected.

CASEWORK CATEGORIES

This section addresses three distinct categories of casework based on the exterior exposed face:

- **WOOD CASEWORK** with wood faces for transparent or opaque finish.
- **DECORATIVE LAMINATE CASEWORK** with HPDL or LPDL faces.
- **SOLID PHENOLIC CASEWORK** with solid phenolic faces.

CONTRACT DOCUMENTS

Shall clearly indicate or delineate all material, fabrication, installation, and applicable building code/regulation requirements, and:

- It is the design professional's responsibility to evaluate the fastening methods required and modify as appropriate to ensure adequate in wall blocking and fasteners are used for the project conditions.
- Compliance to **SEISMIC** requirements for casework fabrication and restraint, where required, shall be so specified. Within the United States, the International Building Code (IBC) establishes these minimum requirements; however, some states have expanded on the U.S. requirements. Within Canada, the National Building Code (NBC) establishes these minimum requirements; however, some provinces and cities have expanded on the Canadian requirements.

- Any **CHEMICAL** or **STAIN RESISTANT** surface requirements must be specified. Consider the chemical and staining agents that might be used on or near the surfaces. Chemical resistance and stain resistance are affected by concentration, time, temperature, humidity, housekeeping, and other factors. It is recommended that actual samples are tested in a similar environment with those agents.
- Any **ABRASION RESISTANT** surface requirements must be specified. Consider the abrasive elements that might be used on or near the surfaces. Common guidelines can be found at:
 - ASTM C501 (latest edition).
 - NEMA LD3-3.13 (latest edition).
 - NEMA LD3.7 (latest edition).

UNLESS SPECIFIED OTHERWISE

- **CORNERS** created by tall, wall, or base casework will create non usable space.
- **FINISHED ENDS** shall be integral, not applied secondarily, except:
 - **APPLIED END PANELS** are allowed at Solid Phenolic casework and at teaching wall assemblies.
- **BASE/TOE** shall be integral (constructed as an integral part of the cabinet body) or separate (constructed as a separate member) at manufacturer's choice.
- **STORAGE, JANITOR CLOSET, and/or UTILITY ROOM CABINETS** shall be built in conformance to Economy Grade, regardless of the overall project's Grade requirement, unless specified otherwise.
- Surfaces behind **PRESENTATION PANELS** (such as white board or tack board) are treated as:
 - Semi Exposed at Economy Grade and Custom Grade.
 - Exposed at Premium Grade.

- **TOE BASE HEIGHT VARIANCE** due to floor variations is not considered a defect. Casework is required to be installed level; shimming of the toe base, not to exceed 1/2" (12.7 mm), is acceptable. Floor variations exceeding 1/2" (12.7 mm) shall be corrected before cabinets are installed; however, correction of such is not the responsibility of the cabinet installer.

SURFACE TERMINOLOGIES

Cabinet surfaces are defined in four distinct categories, three for exposed surfaces with very specific minimum surface requirements and one for concealed surfaces subject to manufacturer's choice, as follows:

- **EXPOSED EXTERIOR SURFACES**, defined as all exterior surfaces exposed to view, including:
 - All surfaces visible when doors and drawers are closed, including knee spaces.
 - Underside of cabinet bottoms over 42" (1067 mm) above the finished floor, including cabinet bottoms behind light valances and the bottom edge of light valances.
 - Cabinet tops under 80" (2032 mm) above the finished floor, or if 80" (2032 mm) and over and visible from an upper building level or floor.
 - Front edges of stretchers, ends, divisions, tops, and bottoms.
 - Sloping tops of cabinets that are visible.

SECTION 10

Casework

introductory information

SURFACE TERMINOLOGIES (continued)

• **EXPOSED INTERIOR SURFACES**, defined as all interior surfaces exposed to view in open casework or behind transparent doors, include:

- Shelves, including edgbanding.
- Divisions and partitions (front edge is an exposed surface).
- Interior face of ends (sides), backs, and bottoms (including pull outs). Also included are the interior surfaces of cabinet top members 36" (914 mm) or more above the finished floor.
- Interior face of door and applied drawer fronts.

• **SEMI-EXPOSED SURFACES**, defined as those interior surfaces only exposed to view when doors or drawers are opened, include:

- Tops and bottoms of shelves, including front edgbanding (front edge is an exposed surface).
- Divisions and partitions (front edge is an exposed surface).
- Interior face of ends (sides), backs, and bottoms (including a bank of drawers). Also included are the interior surfaces of cabinet top members 36" (914 mm) or more above the finished floor.
- Drawer sides, sub fronts, backs, and bottoms.
- The underside of cabinet bottoms between 24" (610 mm) and 42" (1067 mm) above the finished floor.
- Security and dust panels or drawer stretchers.

• **CONCEALED SURFACES**, defined as those exterior or interior surfaces that are covered or not normally exposed to view including:

- Toe space unless otherwise specified.
- Sleepers, stretchers, and solid sub tops.
- The underside of cabinet bottoms less than 24" (610 mm) above the finished floor.

- The underside of countertops, knee spaces, and drawer aprons.
- The flat tops of cabinets 80" (2032 mm) or more above the finished floor, except if visible from an upper floor or building level.

- The three non visible edges of adjustable shelves.
- The faces of cabinet ends of adjoining units that butt together.

SURFACE TERMINOLOGY BY ILLUSTRATION

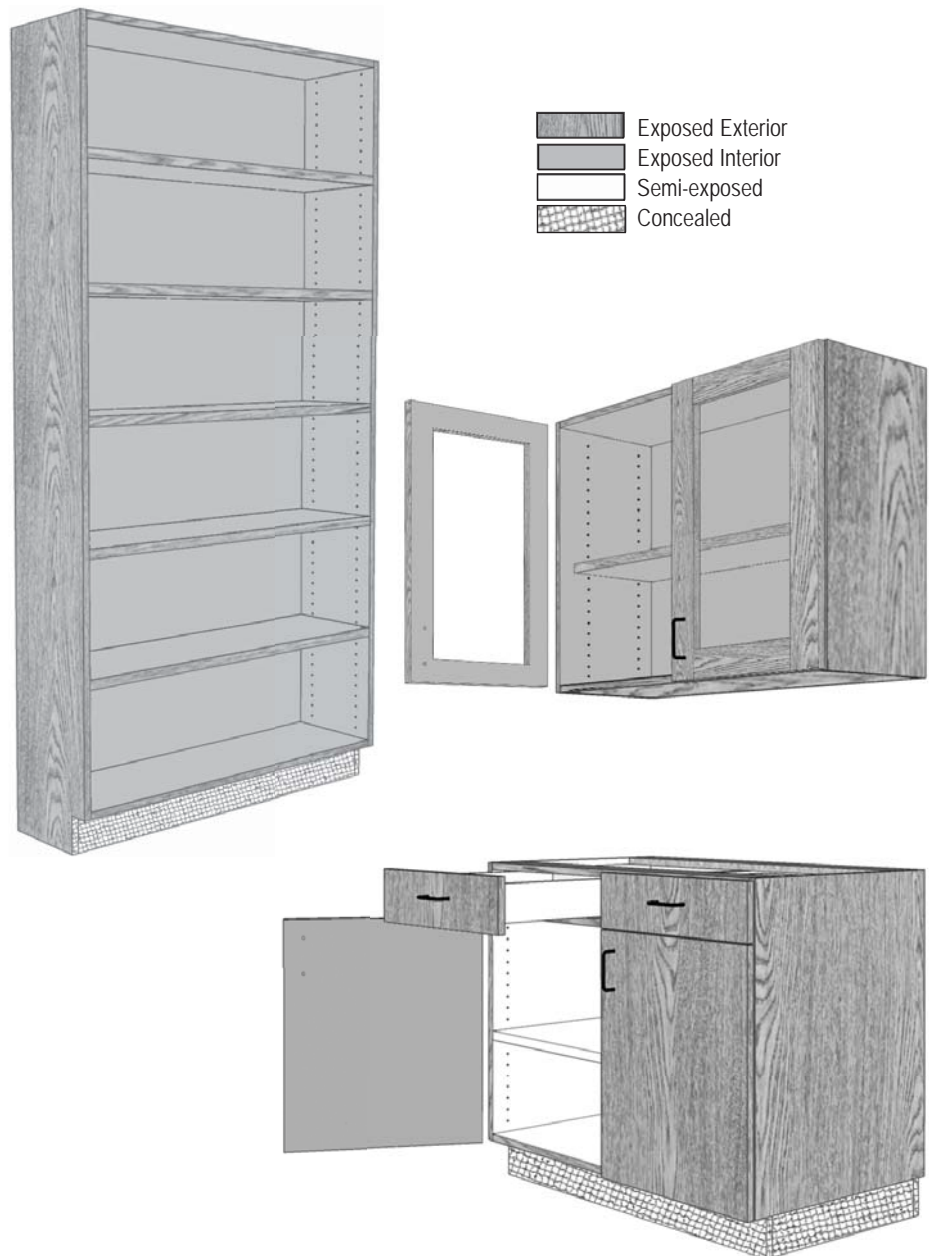

Figure: 10-001

introductory information

SURFACE FINISH REQUIREMENTS

- **EXPOSED EXTERIOR SURFACES** for:
 - **WOOD** casework requires:
 - For **TRANSPARENT** finish, wood of specified species, cut, and match.
 - For **OPAQUE** finish at:
 - **ECONOMY GRADE**, Particleboard, MDF, MDO, softwood plywood, hardwood plywood, or solid stock.
 - **CUSTOM GRADE**, MDF, MDO, close grain hardwood plywood, or solid stock.
 - **PREMIUM GRADE**, MDF and MDO.
 - **DECORATIVE LAMINATE** casework requires at:
 - **ECONOMY GRADE**, LPDL of specified color or pattern.
 - **CUSTOM** and **PREMIUM GRADE**, HPDL of specified color or pattern.
 - **SOLID PHENOLIC** casework requires for **PREMIUM GRADE**, solid phenolic of specified color or pattern.
- **EXPOSED INTERIOR SURFACES** for:
 - **ECONOMY GRADE** at:
 - **WOOD** casework requires:
 - For **TRANSPARENT** finish, LPDL or wood of the manufacturer's choice.
 - For **OPAQUE** finish at, Particleboard, MDF, MDO, softwood plywood, hardwood plywood, or solid stock of manufacturer's choice.
 - **DECORATIVE LAMINATE** casework requires, LPDL of the manufacturer's choice.
 - **CUSTOM GRADE** at:
 - **WOOD** casework requires:
 - For **TRANSPARENT** finish, wood of the same species as the exposed exterior surface.
 - For **OPAQUE** finish at, MDF, MDO, close grain hardwood plywood, or solid stock of manufacturer's choice.
 - **DECORATIVE LAMINATE** casework requires HPDL or LPDL compatible to exposed exterior surface in color, grain, or pattern of manufacturer's choice.
 - **PREMIUM GRADE** at:
 - **WOOD** casework requires:
 - For **TRANSPARENT** finish, wood of same the species and cut as the exposed exterior surface.
 - For **OPAQUE** finish, use of MDF and MDO of manufacturer's choice.
 - **DECORATIVE LAMINATE** casework requires, HPDL, the same as the exposed exterior surface.
 - **SOLID PHENOLIC** casework requires, solid phenolic, the same as the exposed exterior surface.
- **SEMI-EXPOSED SURFACES** for:
 - **WOOD** casework require for both **TRANSPARENT** and **OPAQUE** finish at:
 - **ECONOMY GRADE**, wood of the manufacturer's choice of species, MDO, MDF, particleboard, or LPDL of the manufacturer's choice of color.
 - **CUSTOM GRADE**, wood of the manufacturer's choice of species, or LPDL of the manufacturer's choice of color.
 - **PREMIUM GRADE**, wood of a compatible species to the exposed.
 - **DECORATIVE LAMINATE** casework at all grades requires, LPDL of the manufacturer's choice of color.
 - **SOLID PHENOLIC** casework requires, solid phenolic of the mill's choice of color.
 - **CONCEALED SURFACES** for all grades at, decorative laminate, wood, and solid phenolic casework require the manufacturer's choice.

SECTION 10

Casework

introductory information

CABINET CONSTRUCTION TERMINOLOGY

FRAMELESS construction where the front edge of the cabinet body components are edgebanded.

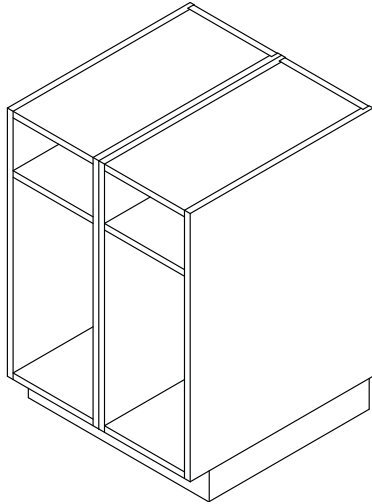

Figure: 10-003

FACE FRAME construction where the front edge of the cabinet body components are overlaid with a frame.

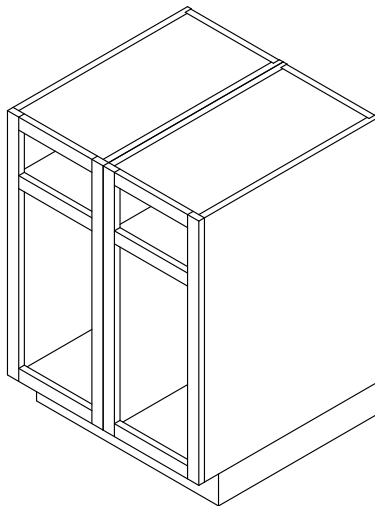

Figure: 10-004

SELECTION shall be manufacturer's choice, unless specified otherwise.

CABINET AND DOOR INTERFACE TERMINOLOGY

FLUSH OVERLAY is the default for either **FRAMELESS** or **FACE FRAME** casework:

• **OVERLAY** including flush, reveal, or lipped, as illustrated below:

• **FRAMELESS Construction:**

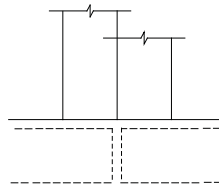

Flush Overlay

Figure: 10-005

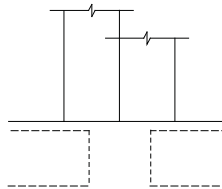

Reveal Overlay

Figure: 10-006

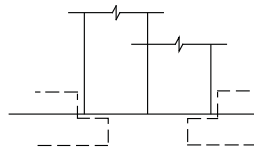

Lipped

Figure: 10-007

• **FACE FRAME Construction:**

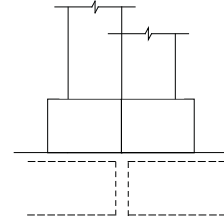

Flush Overlay

Figure: 10-008

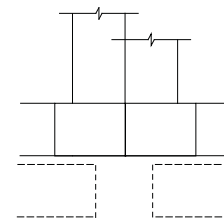

Reveal Overlay

Figure: 10-009

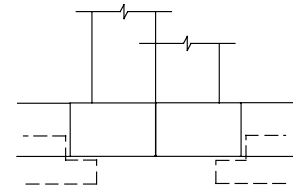

Lipped

Figure: 10-010

• **FLUSH INSET**, as illustrated below:

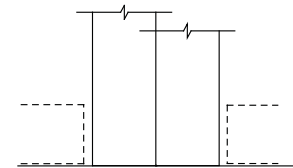

Frameless Construction

Figure: 10-011

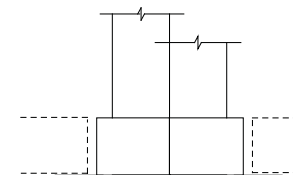

Face Frame Construction

Figure: 10-012

introductory information

LAYOUT REQUIREMENTS OF GRAINED OR PATTERNED FACES BY GRADE

- **STILE** and **RAIL** doors and drawer fronts for all Grades, drawer fronts shall run either vertically or horizontally at the manufacturer's choice for the entire project. Doors shall be vertical.



Figure: 10-013



Figure: 10-014

- **FLUSH PANEL** doors and drawer fronts:
 - **ECONOMY GRADE** - drawer fronts shall run either vertically or horizontally at the manufacturer's choice for the entire project. Doors shall be vertical. Mismatch is allowed:



Figure: 10-015

- **CUSTOM GRADE** - doors, drawer fronts, and false fronts shall run and match vertically within each cabinet unit:

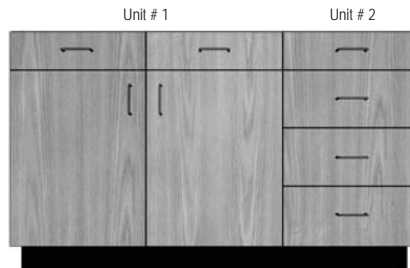

Figure: 10-016

- **PREMIUM GRADE** - doors, drawer fronts, and false fronts shall run and match vertically and be sequenced horizontally within each cabinet unit; and at cathedral grain, the crown shall be pointing up and run in the same direction for the entire project. Doors, drawer fronts, and false fronts shall be well matched for color and grain across multiple cabinet faces in one elevation. Requirement for blueprint or sequencing between cabinet units must be so specified.



Figure: 10-017

DOOR AND APPLIED DRAWER FRONT PROFILES

For illustration purposes only and are not intended to be duplicated exactly:

- Common **EDGE PROFILES**:
 - Square edge with thin applied edgeband.

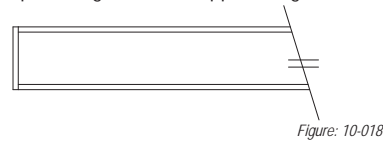

Figure: 10-018

- Radius edge with thick applied edgeband.

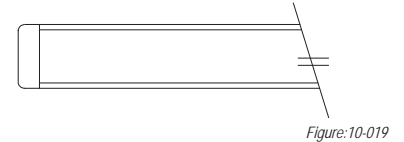

Figure: 10-019

- Square edge with thick applied edgeband:

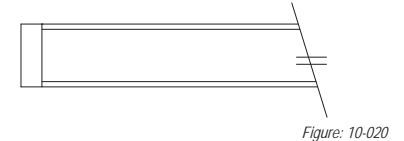

Figure: 10-020

- Square edge with inset edgeband.

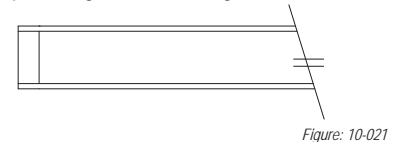

Figure: 10-021

- Lipped edge with inset edgeband:

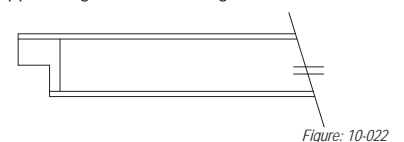

Figure: 10-022

To **PREVENT TELEGRAPHING**, inset solid wood edging when used must have similar moisture content as panel core, be glued securely and calibrated with panel core thickness prior to being laminated with a wood veneer on both faces.

- Common **RETENTION PROFILES**:

- Fixed panel.

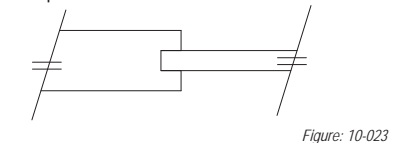

Figure: 10-023

- Removable stop.

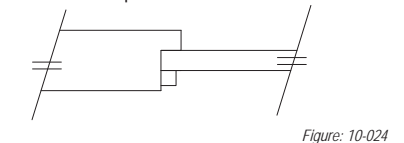

Figure: 10-024

- Removable stop at HPDL face.

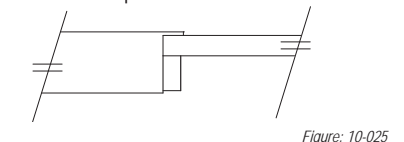

Figure: 10-025

DOOR AND APPLIED DRAWER FRONT PROFILES (continued)

- Removable stop, synthetic.

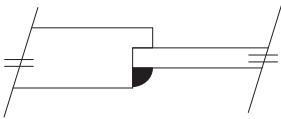

Figure: 10-026

- Removable retainer, synthetic.

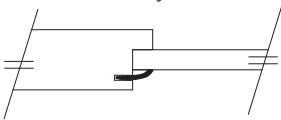

Figure: 10-027

- Removable clips.

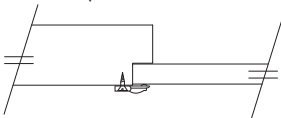

Figure: 10-028

CABINET DESIGN SERIES (CDS)

Details were developed by the industry and represent a series of numbered cabinet designs that are available for ease of specification and drawing. A numerical/elevation key to the CDS may be found in **DESIGN IDEAS**.



CAD details are available in both Autodesk Revit Families and AutoCAD ".dwg / .dxf" files of the elevations may be found on the Sponsor Associations' websites:

- Architectural Woodwork Institute - www.awinet.org.
- Architectural Woodwork Manufacturers Association of Canada - www.awmac.com.
- Woodwork Institute - www.woodworkinstitute.com.

These cabinets may be specified by number to a specific size requirement on the plan view drawings without having to draw elevations. They are drawn as 'Frameless Construction, flush overlay Interface', with integral finished ends and scribes at wall to wall installations not exceeding 1-1/2" (38.1 mm) in width.

CASEWORK INTEGRITY

These standards have adopted a portion of SEFA's (Scientific Equipment and Fixture Association) methods of testing and acceptable results as the minimum acceptable level of integrity for casework, as found in the **APPENDIX**.



CABINET HARDWARE

These standards have adopted ANSI/BHMA Standards (latest edition), Grade 2, as the basic minimum requirement. For more specific details, see the **PRODUCT** portion of this Section. Choice of product should be made on the basis of utility, aesthetics, security objectives, and the end use desired. As a general guide:

- **GRADE 1** is the highest and is suitable for most institutional applications.
- **GRADE 2** is used in most other applications.

DRAWER SLIDE SELECTION GUIDE

The following serves as both a checklist and a starting point for the discussion of a wide variety of drawer slide systems. While by no means exhaustive, the characteristics described below are often considered the most important by the client, the design professional, and the woodwork manufacturer. The selection of the slide characteristics will affect the usefulness of the cabinets. Careful consideration should be given to avoid "over specifying" for the purpose intended:

- **DEGREE OF EXTENSION:**
 - **STANDARD EXTENSION**, all but 4" - 6" (101.6 - 152.4 mm) of drawer body extends out of the cabinet.
 - **FULL EXTENSION**, entire drawer body extends out to the face of cabinet.
 - **FULL EXTENSION with over travel**, entire drawer body extends beyond the face of cabinet.

• STATIC LOAD CAPACITY:

- 50 pounds, residential and light commercial.
- 75 pounds, commercial.
- 100 pounds, heavy duty.
- Over 100 pounds, special conditions, extra heavy duty.

• DYNAMIC LOAD CAPACITY:

- 30 pounds for 35,000 cycles, residential and light commercial.
- 50 pounds for 50,000 cycles, commercial.
- 75 pounds for 100,000 cycles, heavy duty.

• REMOVAL:

- **Passive disconnect** - A means of drawer removal that does not require active disconnecting.
- **Positive disconnect** - A means of removing a drawer that requires active disconnection or removal of hardware.

• CLOSING:

- **Self closing/stay closed**, drawer slides will self close with the related dynamic load when the drawer is 2" (50.8 mm) from the fully closed position and not bounce open when properly adjusted.

• METAL SIDED DRAWER SYSTEMS must be specified and should require:

- **Positive stop**, drawer must stop within itself and not rely on the drawer front to stop it.
- **Pullout strength**, system must demonstrate sufficient strength of attachment of front to sides, design professional should evaluate and approve individually.

introductory information

HINGE SELECTION GUIDE

Architectural cabinet hinges will usually be furnished from the manufacturer's stock unless otherwise specified. The three most common hinge types are illustrated below.

European hinges with the screws set in synthetic inserts are an established industry standard. These hinges have been found to be cost effective alternatives to the more traditional hinges shown below. Follow hinge manufacturers' recommendations on number and spacing of hinges. There are conditions, however, in which the use of butt or wraparound hinges will continue to be the best solution. Pivot hinges often require a cut in center hinge. Consult manufacturer's recommendations:

- **European style hinge**, typically used in conventional flush without face frame and reveal or flush overlay application offering moderate strength, full concealment, moderate cost, ease of installation and adjustment.

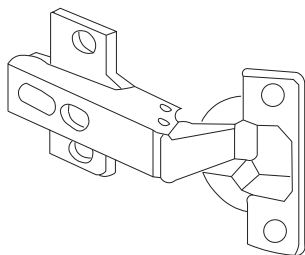

Figure: 10-029

- **Wraparound hinge (3 & 5 knuckle)**, typically used in flush and reveal overlay applications offering very high strength, moderate cost, ease of installation and moderate ease of adjustment; however, can require mortising and shows an exposed knuckle and hinge body.

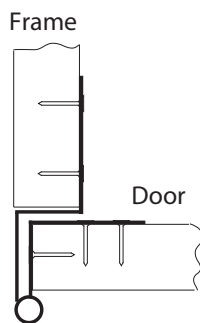

Figure: 10-030

- **Butt hinge**, typically used in conventional flush with face frame application, offering high strength, low cost, moderate ease of installation and adjustment; however, can require mortising and shows an exposed knuckle.

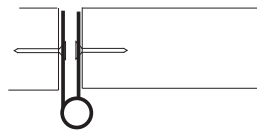

Figure: 10-031

ADJUSTABLE SHELF LOADING and DEFLECTION

Proper specification can balance aesthetic needs with load requirements.

Load is the total applied weight, uniformly dispersed on an individual shelf, not to exceed 200 lbs (90.7 Kg) on any one shelf. These standards have adopted the following load capacities:

- 50 lbs per sq ft (244.1 kg/m²) for school, hospital, and library or book shelving.
- 40 lbs per sq ft (195.3 kg/m²) for all other shelving.

Shelving specification requires consideration of deflection, the measured distance from a straight line that a shelf will deflect under load. L/144 (the length of the shelf divided by 144) is the industry standard for the maximum acceptable deflection of a shelf, which permits 1/4" (6.4 mm) deflection in a 36" (914 mm) shelf.

Creep is the increase in deflection over time, which fluctuates with temperature, humidity, and load stress. Creep is not considered a defect; if it is a concern, it can be reduced by:

- Reduced loading of shelves.
- Use of material with a higher (stiffer) modulus of elasticity (MOE).
- Use of alternate construction (support) techniques.
- Use of a decreased factor of acceptable deflection.

CONSTRUCTION DETAIL NOMENCLATURE

Familiarity with the labeled details on this and following pages will facilitate communication between architects, designers, specifiers, and woodwork manufacturers by establishing common technical language:

- **STUB TENON** - Joinery method for assembling stile and rail type frames that are additionally supported, such as web or skeleton case frames.

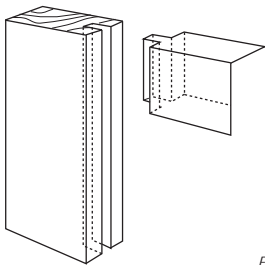

Figure: 10-032

- **HAUNCH MORTISE AND TENON JOINT** - Joinery method for assembling paneled doors or stile and rail type paneling.

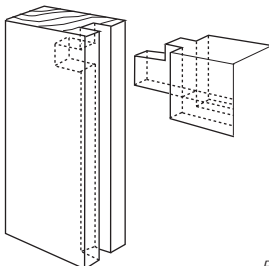

Figure: 10-033

- **CONVENTIONAL MORTISE AND TENON JOINT** - Joinery method for assembling square edged surfaces such as case face frames.

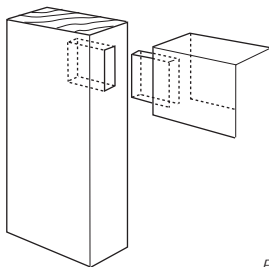

Figure: 10-034

- **DOWEL JOINT** - Alternative joinery method serving same function as Conventional Mortise and Tenon.

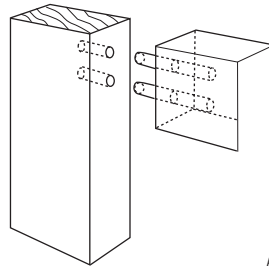

Figure: 10-035

- **FRENCH DOVETAIL JOINT** - Method for joining drawer sides to fronts when fronts conceal metal extension slides or overlay the case faces.

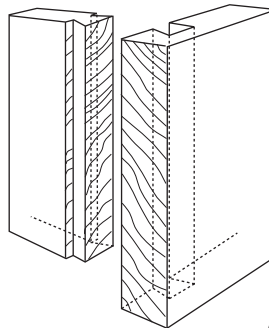

Figure: 10-036

- **CONVENTIONAL DOVETAIL JOINT** - Traditional method for joining drawer sides to fronts or backs. Usually limited to flush or lipped type drawers.

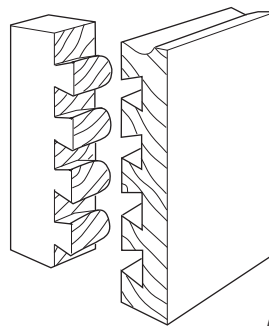

Figure: 10-037

- **DRAWER LOCK JOINT** - Another joinery method for joining drawer sides to fronts. Usually used for flush type installation, but can be adapted to lip or overlay type drawers.

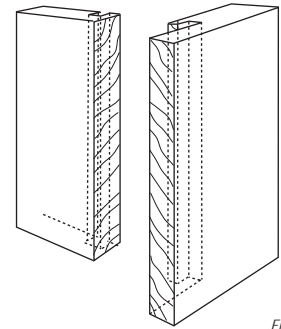

Figure: 10-038

- **EXPOSED END DETAILS** - Illustrates attachment of finished end of case body to front frame using:

- **BUTT JOINT**

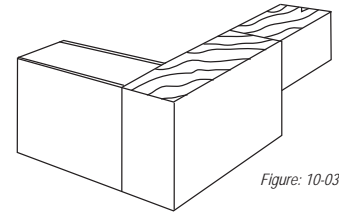

Figure: 10-039

- **SHOULDER MITERED JOINT.**

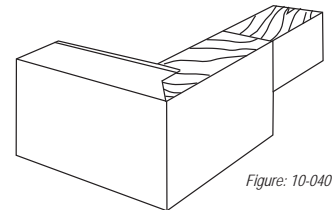

Figure: 10-040

- **POCKET SCREW JOINT.**

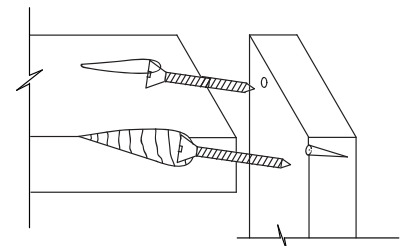

Figure: 10-041

introductory information

- **THROUGH DADO** - Conventional joint used for assembly of case body members. Dado not concealed by application of case face frame.

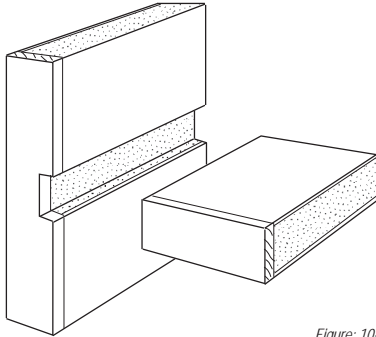

Figure: 10-042

- **DOWEL JOINT** - An established industry standard assembly method, this versatile joinery technique is often based on 1-1/4" (32 mm) spacing of dowels.

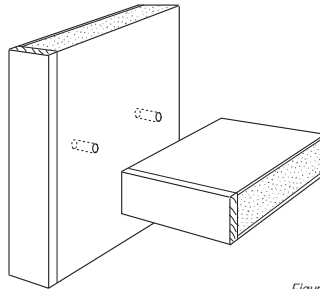

Figure: 10-045

- **BLIND DADO** - Variation of Through Dado with applied edge "stopping" or concealing dado groove.

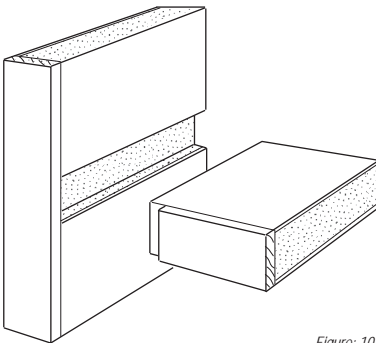

Figure: 10-043

- **DOWEL SCREW JOINT** - An alternative to the dowel joint above.

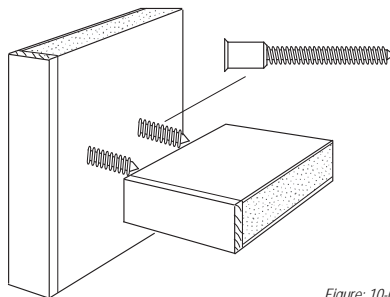

Figure: 10-046

- **STOP DADO** - Another method of concealing dado exposure. Applicable when veneer edging or solid lumber is used. Exposed end detail illustrates attachment of finished end of case body to front frame using butt joint.

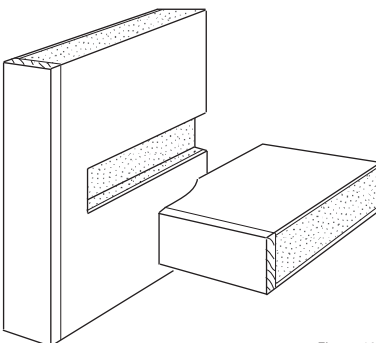
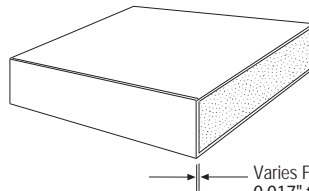

Figure: 10-044

- **EDGE BANDING** - Method of concealing plies or inner cores of plywood or particleboard when edges are exposed. Thickness or configuration will vary with manufacturers' practices.



Varies From
0.017" to 0.118"
(0.45 mm to 3 mm)

Figure: 10-047

- **MITER / MITER FOLD JOINT.**

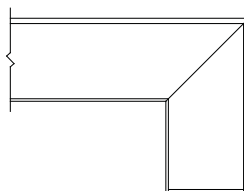

Figure: 10-048

- **SPLINE JOINT**: Used to strengthen and align faces when gluing panels in width or length, including items requiring site assembly.

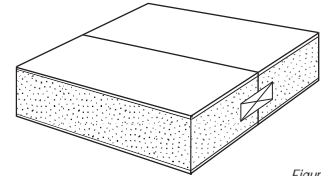

Figure: 10-049

- **PANELED DOOR DETAILS** - Joinery techniques when paneled effect is desired. Profiles are optional as is the use of flat or raised panels. Solid lumber raised panels may be used when width does not exceed Custom Grade standard. Rim raised panels are required for Premium Grade or when widths exceed Custom Grade or when transparent finish is used.

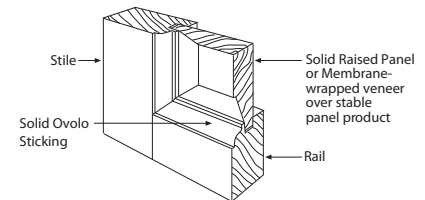

Figure: 10-050

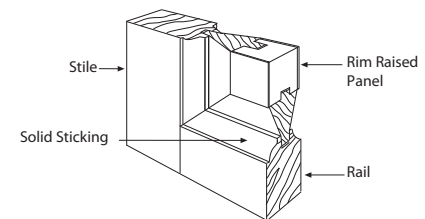

Figure: 10-051

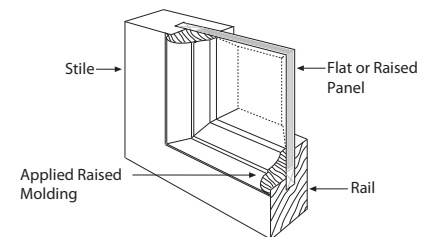

Figure: 10-052

SECTION 10

Casework

introductory information

SPECIFY REQUIREMENTS FOR

- Construction type.
- Door and drawer front Interface style.
- Door and drawer front edge profile.
- Toe base finish.
- Grain direction, if other than vertical.
- Inside clearance.
- Seismic fabrication and/or installation.
- Flame spread rating.
- Moisture resistance.
- Insulation from adjacent heating cooling sources.
- Hardware.
- Laboratory features, such as:
 - Pipe chase allowance and/or removable backs behind base cabinets.
 - Removable top at countertop splash.
 - Moisture resistant base.
 - Chemical resistant finish or surfaces.
- At wood casework:
 - Species of veneer.
 - Method of slicing (plain, quarter, rift, or rotary).
 - Matching of veneer leaves (book, slip, or random).
 - Matching of veneer leaves within the face of a cabinet unit.
 - Matching between doors, drawers, and adjacent panels (non sequenced, sequenced, or blueprint).
 - End matching.
 - Grain direction, if other than vertical.

RECOMMENDATIONS

- If **FIELD FINISHED**, include in Division 09 of the specifications:
 - **BEFORE FINISHING**, exposed portions of woodwork shall have handling marks or effects of exposure to moisture, removed with a thorough, final sanding over all surfaces of the exposed portions and shall be cleaned before applying sealer or finish.
- At **CONCEALED SURFACES** - Architectural woodwork that may be exposed to moisture, such as those adjacent to exterior concrete walls, etc., shall be primed.
- **REVIEW** the **GENERAL** portion of Sections 3 and 4 for an overview of the characteristics and the minimum acceptable requirements of lumber and/or sheet products that might be used herein.
- **STRUCTURAL MEMBERS**, grounds, in wall blocking, backing, furring, brackets, or other anchorage which becomes an integral part of the building's walls, floors, or ceilings, required for the installation of architectural woodwork are not to be furnished or installed by the architectural woodwork manufacturer or installer.